



Installation instruction



PIN code



Fingerprint



APP



Card



Bluetooth

1 Instructions for use and product diagrams

Dear user!

Thank you for using this smart lock. Before you install and use it ,please check the List of accessories carefully. Please read the installation instructions and follow its steps, otherwise we will not be responsible for any hazards or damages.

⚠ Important Notes: Please set the function according to the appropriate product

1, The original password and the initial administrator password are: 123456

2, Card quantity: 1000

3, fingerprint quantity: 100







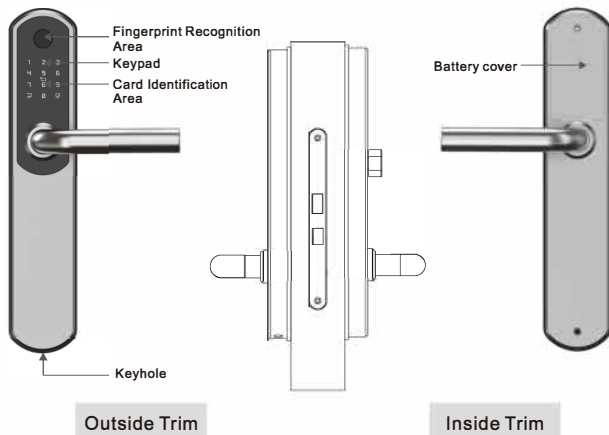



4, PIN code quantity: 250

5, When low battery alarm, please replace the same type of battery in time and pay attention to the positive and negative pole installation to ensure the normal use of the lock. (New and old batteries cannot be used at the same time)

6, Please keep the mechanical key with you when not in use and do not keep it indoor.



2 Package List

<p>A. Outside Trim</p> 	<p>B. Inside Trim</p> 	<p>C. Rear back plate</p> 
<p>D. Waterproof rubber pad</p> 	<p>E. Square bar</p> 	<p>F. Stud</p> 
<p>G. Screw</p> 	<p>H. Inside trim screws</p> 	<p>I. Battery cover screws</p> 
<p>J. Backplane screws</p> 	<p>K. RFID Card</p> 	

3 Know before installing

- 3.1 Please confirm the opening direction before installation
Fitting direction: Left outward, Left inward, Right outward, Right inward

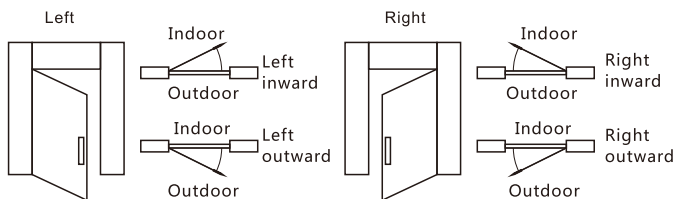

- 3.2 The way of turning the handle to left or right.
Please install the handle according to the direction of your door opening.

To change the direction of the handle, using cross screwdriver to loosen the screw, removing the handle, adjusting the handle according to the required direction, and then tighten the handle with a screw.



4 The steps of installation



Install the lock case

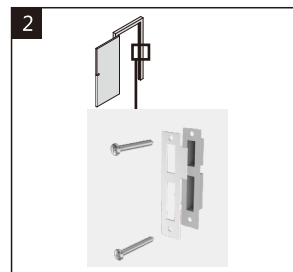

Install the Strike plate and the box

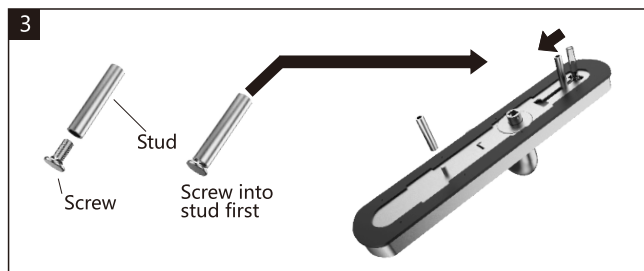

Fix the stud onto the front lock and adjust the upper screw to the corresponding position on the plate according to the hole position.

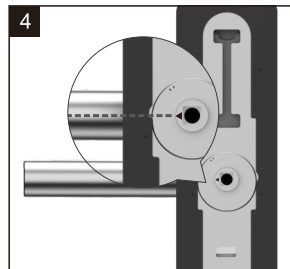

Adjust the direction of the handle for the front lock, fix the bolts, and then turn the square axis with a triangle indicating that the arrow is facing towards the direction of the handle.

4 The steps of installation

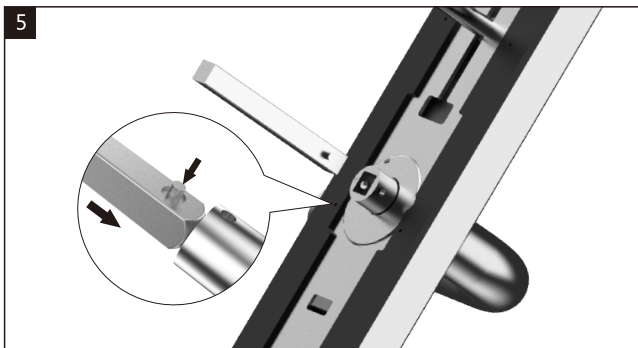

Insert the spindle into the spindle hole and make the dowel pin on the square rod. Stuck in the square shaft holes

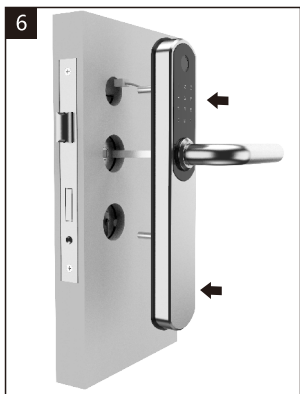

Install the front lock

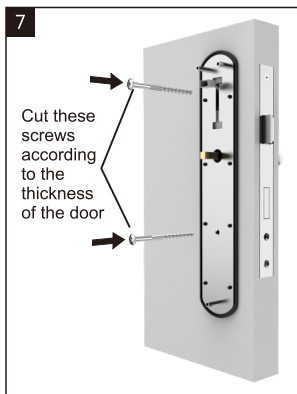

Secure the rear base plate with screws

4 The steps of installation

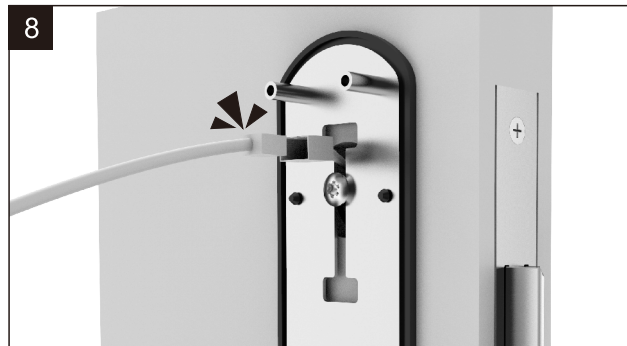

The Outside Trim data cable connects to rear panel data cable, please tuck in the door if the cable is too long



Installation the screws like this



Install the battery

4 The steps of installation



Installation the battery cover

5 Parameter

Surface	Measurement	303mmX57mmX20mm
	Item NO.	U027
	Material	SUS304
Unlocking ways	Fingerprint	Capacity 100
	PIN	Capacity 200
	Card	Capacity 200
	APP	Send door opening commands via Bluetooth
Communication methods	Bluetooth	Synchronize data in close proximity and Firmware upgrade
Working Parameter	Working power supply	4 x 1.5V AAA alkaline batteries
	Low battery alarm	≤ 4.8V
	Standby power	≤85UA, 4 batteries can be used for more than 6 months
	Operating temperature	-30°C to 60°C
	Operating humidness	5%-78%RH

6 APP Guide

6.1 Download "TTLock"APP



Android phone - you can search "TT lock" on Google APP.
Iphone - you can search "TT lock" in the App store

6.2 Registration now account (phone or Email)

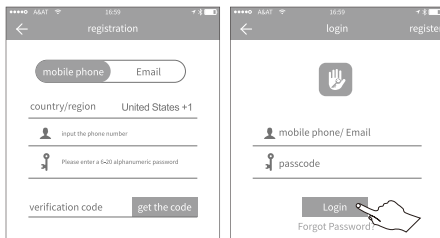
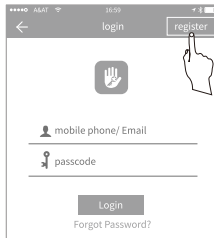

6 APP Guide

6.3 The methods of connecting the lock is as follows

- a Turning on the bluetooth, enter into the APP. For details, please look at the following figure

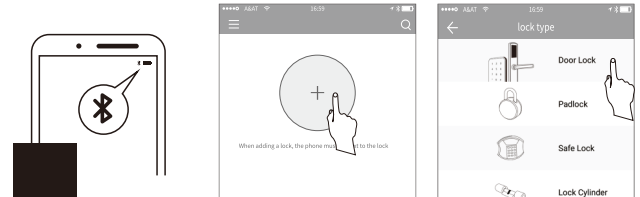

- b Touch the screen of the smart lock, the app will display the relevant information, and then click " + ".

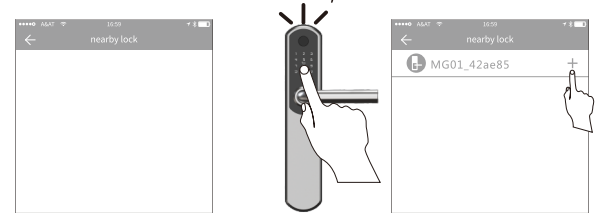

Attention: Please Make sure your phone is within 10 meters of the lock.

6.4 Management of the key

After successfully adding a lock, the administrator will have the highest administrative privilege for that lock, he can send keys to others and specify the time limit. Choose limited time, permanent or single permission. Add the soon to expire key management, i.e. expiration key reminder.

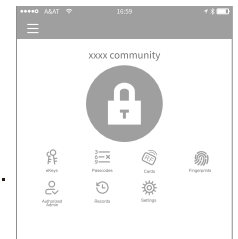

6 APP Guide

When you click on the key type option will bring up the following message.

Limited time key, permanent key and disposable key.

When you select "Limited Time Key", the key will be valid for a specified period of time.

When you select Persistent Key, it means permanently valid.

When you choose "disposable key". It is automatically deleted after one use.

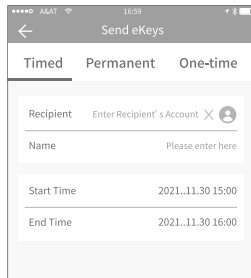
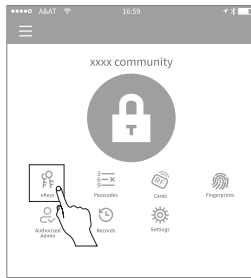

The administrator has the authority to manage all the keys, including: delete the key, reset the key, send the key permissions, adjust the validity period of the key and access record query.

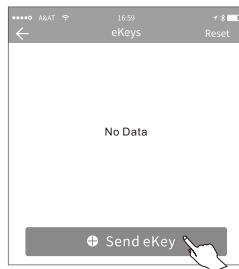
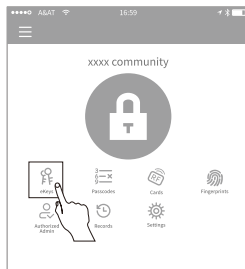

6 APP Guide

6.5 Password management

After entering the password on the keypad, press the unlock key in the lower right corner to unlock the lock. The type of password: permanent, time-limited, lifetime, delete, recycled, and customized.

a Permanent password

permanent password: it can work without time-limit. (note: It need to be activated after created in 24h, otherwise it will lose efficacy)

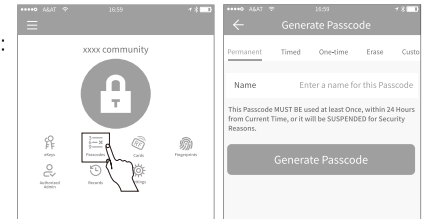

b Timed password

Time password can be set the period of validity. The shortest period is one hour, the longest is 3 years. If it is valid within one year, the time line can be accurate to hour. If will be valid for more than one year, the time line can be accurate to month. (note: It need to be activated after created in 24h, otherwise it will lose efficacy)

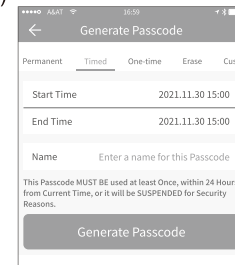

6 APP Guide

c One-time can only use

"One-time password" can only be used once. The validity period is 6 hours

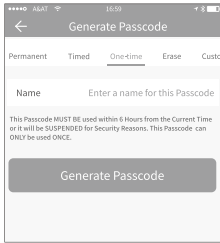

d Erase

Erase code is using for deleting all the password. The validity period is 24 hours

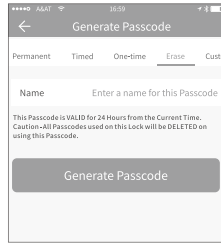

e Custom password

You can configure your own password. It needs the length between 6-9. You can custom password by bluetooth or gateway.

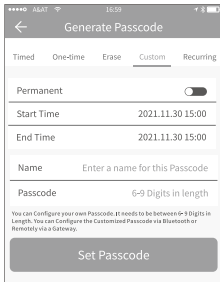

f Recurring Password

Recurring password can be reused within a specified time period, like a daily cycle, weekday circulation, weekend cycle time etc.

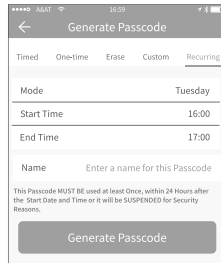

6 APP Guide

g Share the password

Manager can share the password by Wechat, message, email, Facebook, Messenger and Whatsapp.

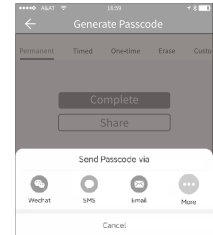

h Password management

All of the generated password can view and manage in the password management module. It includes password permissions and password to unlock, change password, delete the password, to reset the password.

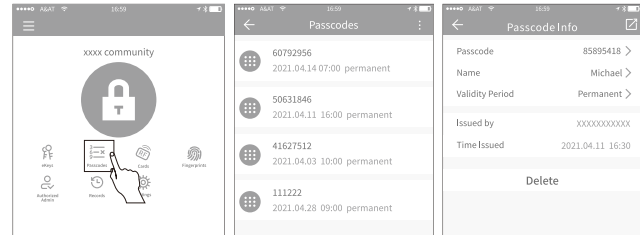

6.6 RIFD card management

You need to add the RFID card. The whole process needs to be done through the lock on the side with the APP application. The validity of the RFID card can be set to permanent or time-limit.

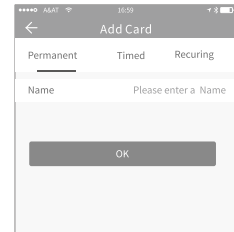

6 APP Guide

All RFID card can be queried and managed by the RFID card management module . If it is the gateway, it will show that send card remotely. If there is no gateway, the project will be hidden.

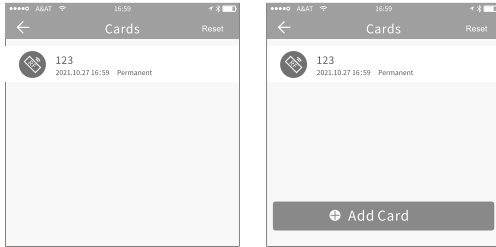

a Add RFID card

As shown in the figure,
step 1. click the "card"
step 2. click the "Add Card"

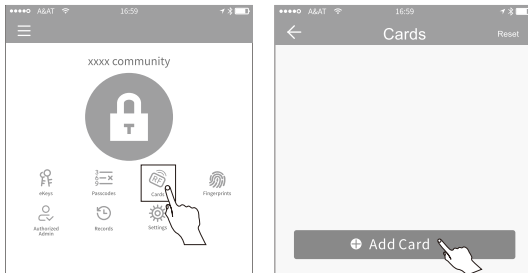

step 1. According to the requirement to select the "permanent", "time" or "cycle" card types.

step 2. The lock can successfully add RFID CARDS when the RFID CARDS close to the lock induction area for 2-3 seconds.

6 APP Guide

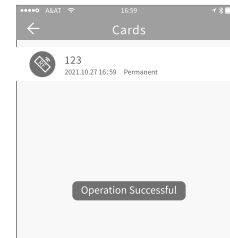
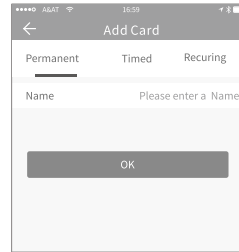

For adding RFID card again, click the "add card" and repeat adding RFID card operation.

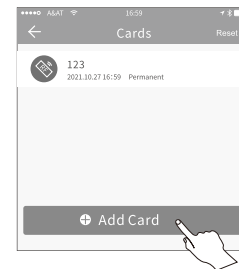

6 APP Guide

b Delete Card

please click the "Reset", then click "Delete" to delete all cards.

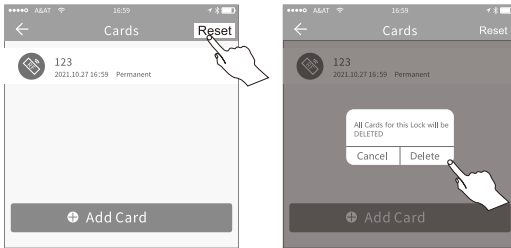

Also user can choose one RFID card

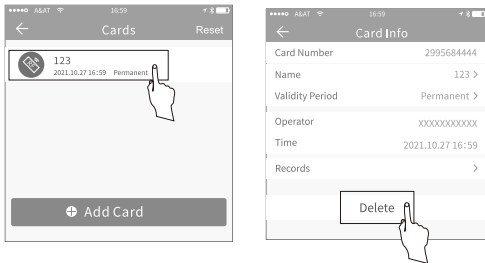

6 APP Guide

a Add fingerprint

Click the "fingerprint", then click "add fingerprint"

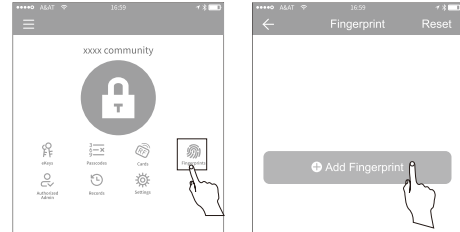

step 1. According to the requirement to select "permanent", "timed" or "cycle" type.
step 2. Then click on "start", you need to input 4 times the fingerprint.

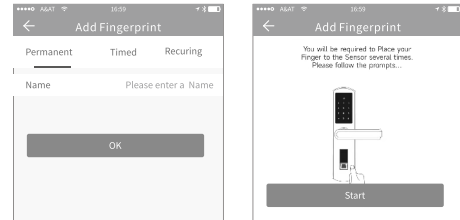

6.7 Fingerprint management

The fingerprint management is similar to the IC card management. After adding fingerprint, users can use fingerprints to unlock.



6 APP Guide

b Delete the fingerprint

Step 1. Select the fingerprint account which you want to delete.

Step 2. click the "Delete"

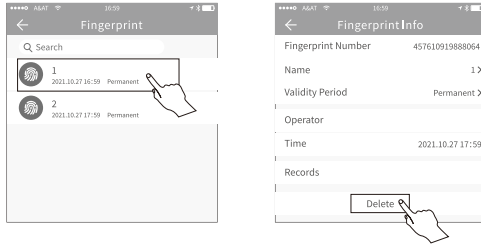

6.8 Records

It can record unlock/lock information. Users can access all the records about the unlock/lock by anytime and

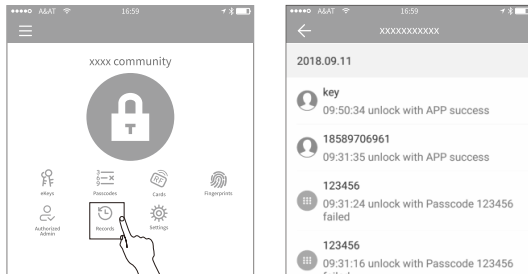

6 APP Guide

6.9 System settings

In the system Settings, it includes touch unlock switch, group management, the gateway management, security Settings, reminding, transfer locks, etc.

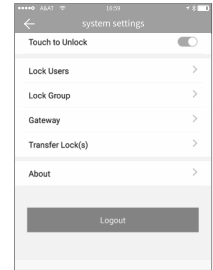

a Users management

In the list of users, manager can see the user name and phone number. manager can click the user account to view the lock information.

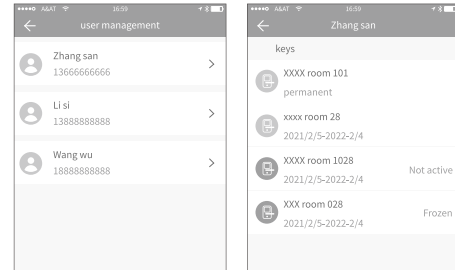

b Group management

manager can use group management module, if there are numbers of keys.

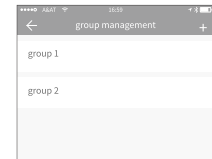

6 APP Guide

c Transfer the rights of administrators

The administrator can transfer the right to other users or room master.

Only the administrator has the right to transfer lock management account.

Enter the account, you will receive a verification code.

Fill in the correct number, you will be successful transfer.

The account for receiving apartment transfer must be an administrator account

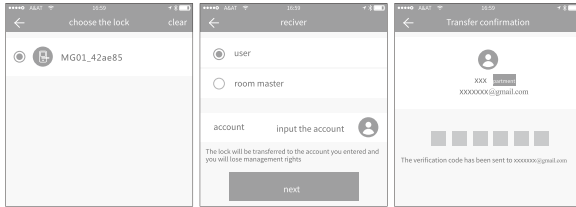

d Reciver

If the lock has been damaged and cannot be deleted, you can move it to the reciver (recycle bin) to delete the lock.

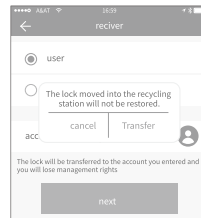

6 APP Guide

6.10 Automatically locked mode

Automatically lock mode can be set in the application (5s, 10s, 15s, 30s, 60s, custom set). When using the APP, password or RFID card to unlock, it will be automatically locked after setting time.

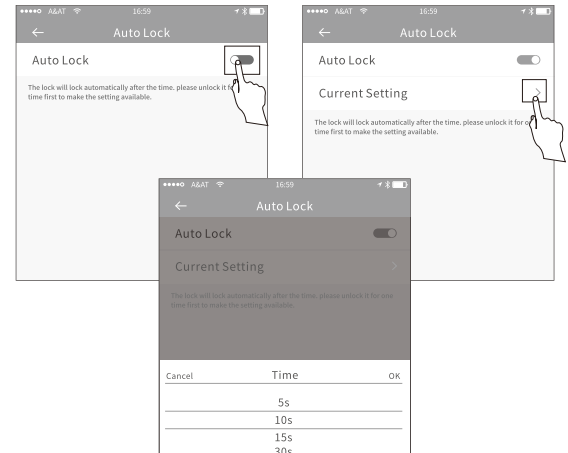
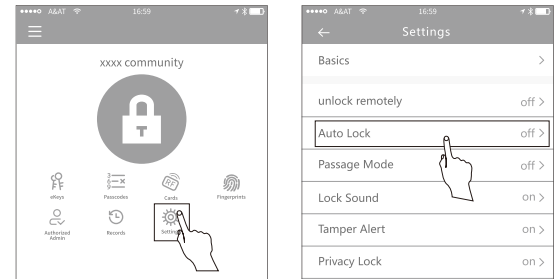

7 The gateway management

Gateway Management (gateways need to be purchased separately)

Intelligent locks connect directly by Bluetooth, so they are not vulnerable to cyber attacks. The gateway is the bridge between the intelligent lock and the home WIFI network. Users can remotely view and calibrate the lock clock and read the unlock records by gateway. At the same time, it can delete and change passwords remotely.



User need to add the gateway in APP before use. Below is the steps:

- (1) open the TTLOCK applications;
- (2) click the "☰" icon which is on the top left corner of the page .
- (3) choose [gateway];
- (4) select the "G2"
- (5) inserted the gateway and turned on the power;
- (6) when the light is alternating flashing red and blue, press "+" symbol;
- (7)Add the gateway;
- (8) choose WiFi network and input password

⚠ Note: if it process timed out, please turn the power off and try it again.

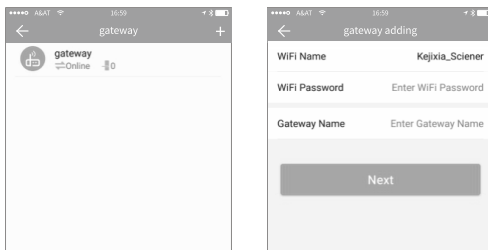

8 Other instructions

8.1 Low battery warning

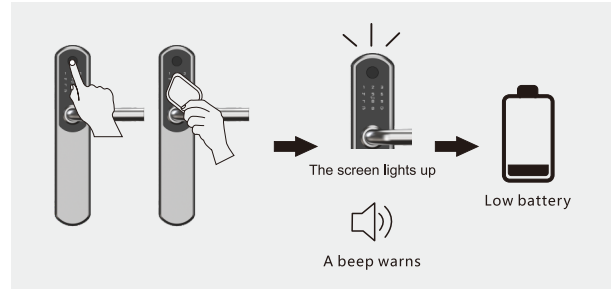

Low battery warning: When intelligent lock unlock, the screen will light up and issued "beep" sound.

8.2 Restore Factory Setting

8.2.1 Restore Factory Setting on APP

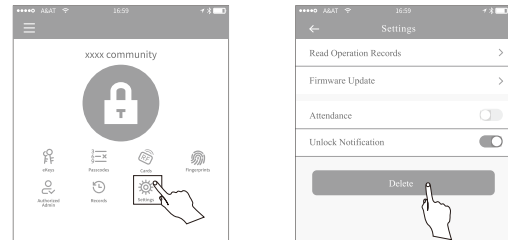

Click "setting"

Click "Delete" and enter password. The product will be restored factory setting.

8 Other instructions

8.2.2 Restore Factory Setting by reset button

Press and hold the reset button for six seconds until you hear a splash.

Note: This operation requires that the data cable is properly connected and the battery is installed. The button is located on the back of the rear panel.

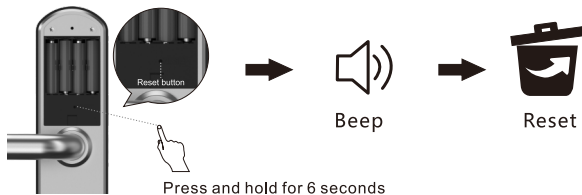

8.3 Problem solving

The smart lock keyboard can not open or close the lock

Verify that the password is correct or the lock is locked. If necessary, please restore the default Settings.

No response when touching the keyboard (no lights, no sound)

Make sure the data connection is correct

Make sure the battery is fresh and installed correctly.

I forgot my admin password

A: restore factory settings to clear all passwords. When the reset is complete, all the passwords will be deleted and the main code will return the default value (123456).

The lock cannot connect to the APP by Bluetooth

please sure Bluetooth is turned on and the APP application is ready to search for the lock state.

Restore the default Settings for locks, if necessary.

Repeated attempts to unlock it but failed to open

use the mechanical key to opens the lock and changes the battery. If necessary, please contact customer service.

9 warranty card

Warranty that

1. Free warranty for 1 year from the date of purchase. If the warranty card and valid purchase certificate cannot be provided, or the purchase certificate has been revised, the warranty period is three months from the date of production.
2. During the warranty period, under the condition of normal use according to the instruction manual, the product defects (judged by the company's official staff); Repair them free of charge.
3. During the warranty period, the following complaints are not free maintenance:
 - Artificial damage caused by improper use, such as improper use of accessories, improper installation, non-compliance with the instructions, incorrect use or negligence, etc. Damage caused by transportation and other accidents. Repairs and modifications not approved by the Company. Other damage caused by force majeure (such as natural disaster, abnormal voltage, etc.).
 - Aging and wear of products caused by normal use shall not affect the normal use of products.
 - The appearance of the product is artificially scratched and damaged, vulnerable and consumable products and nearby products not covered by the warranty, such as batteries.

Product model

Activation code

Dealer name

Purchase date

User name

User address

Staff phone number

Invoice no.

User number